

# ➤ Instructions / Anleitung Instructions / Instrucciones Instructies

## Thule Yepp Nexxt 2 Maxi Frame Mount

12080251, 12080252, 12080253, 12080254,  
12080255, 12080256

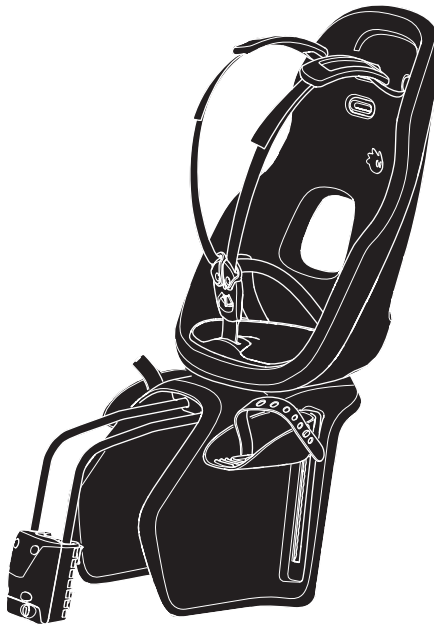

<b>EN</b>	Rear mounted child bike seat	<b>CS</b>	Zadní dětská cyklosedačka
<b>FR</b>	Siège vélo enfant arrière	<b>HU</b>	Kerékpáros hátsó gyerekülés
<b>ES</b>	Asiento para niños en la parte trasera de la bicicleta	<b>RO</b>	Scaun spate de copii pentru bicicletă
<b>DE</b>	Fahrradkindersitz	<b>SK</b>	Zadná detská cyklosedačka
<b>NL</b>	Fietszitzje voor achterop	<b>SL</b>	Zadnji otroški kolesarski sedež
<b>PT</b>	Assento infantil traseiro para bicicleta	<b>BG</b>	Задна детска седалка за велосипед
<b>IT</b>	Seggiolino da bicicletta posteriore	<b>HR</b>	Dječja sjedalica za bicikl koja se postavlja straga
<b>SV</b>	Cykelbarnstol för bakre cykelmontering	<b>EL</b>	Πίσω παιδικό κάθισμα ποδηλάτου
<b>DK</b>	Bagmonteret cykelstol	<b>TR</b>	Arkaya Bağlanan Çocuk Bisiklet Koltuğu
<b>NO</b>	Bakmontert barnesykkelse	<b>MT</b>	Sedil tar-Rota għat-Tfal li Jitpoġġa Wara
<b>FI</b>	Lastenistuin polkupyörän taakse		מושב אופניים אחורי לילד <b>HE</b>
<b>IS</b>	Barnasæti aftan á reiðhjól		مقعد الدراجة الخلفي للطفل <b>AR</b>
<b>ET</b>	Jalgratta tagumine lasteiste	<b>ZH (CN)</b>	后置式儿童自行车座椅
<b>LV</b>	Velosipēda aizmugurējais bērna sēdekļis	<b>ZH (TW)</b>	後座式自行車兒童座椅
<b>LT</b>	Galinė vaikiška dviračio kėdutė	<b>JA</b>	サイクル後部用チャイルドシート
<b>RU</b>	Заднее детское велосипедное сиденье	<b>KO</b>	후면 어린이 자전거 시트
<b>UK</b>	Заднє дитяче велосипедне крісло	<b>TH</b>	เก้าอี้เด็กสำหรับซ้อนท้ายจักรยาน
<b>PL</b>	Fotelik rowerowy do przewożenia dziecka montowany z tyłu	<b>MS</b>	Tempat Duduk Basikal Kanak-kanak Belakang

EN 14344:2022

ASTM F1625-00



- EN** Please read the following instructions carefully and keep them for future reference.
- DE** Bitte die folgenden Anleitung aufmerksam durch und bewahren Sie sie zum späteren Nachschlagen auf.
- FR** Veuillez lire attentivement les instructions suivantes et les conserver pour référence future.
- NL** Dient u zorgvuldig de volgende instructies te lezen en deze als toekomstig naslagwerk te bewaren.
- IT** Leggi le seguenti istruzioni attentamente e conservale per consultazioni future.
- ES** Lea las instrucciones siguientes atentamente y guárdelas para consultas posteriores.
- PT** Leia cuidadosamente as instruções a seguir e guarde-as para referência futura.
- SV** Vi ber dig läsa följande instruktioner noggrant och därefter behålla dem för framtida bruk.
- DK** Skål du læse følgende anvisninger grundigt igennem og gemme dem til fremtidig reference.
- NO** Bør du lese disse instruksjonene nøye. Ta vare på dem i tilfelle du får bruk for dem senere.
- FI** Lue seuraavat ohjeet huolellisesti. Pidä ohjeet tallessa.
- IS** Lestu þessar leiðbeiningar vandlega áður en þú og geymdu þær til síðari nota.
- ET** kasutuselevõttu lugege järgmised juhised hoolikalt läbi ja hoidke need alles.
- LV** lūdzu, izlasiet uzmanīgi tālāk sniegtos norādījumus un saglabājiet tos turpmāki izmantošanai.
- LT** atidžiai perskaitykite toliau pateiktas instrukcijas ir jų neišmeskite, kad galėtumėte peržiūrėti ateityje.
- PL** należy dokładnie przeczytać następujące instrukcje i zachować je do wykorzystania w przyszłości.
- RU** внимательно изучите представленные ниже инструкции и сохраните их для дальнейшего использования.
- UK** ознайомтеся з нижченаведеними інструкціями й зберігайте їх для довідки в майбутньому.
- BG** прочетете внимателно следните инструкции и ги запазете за бъдещи справки.
- CS** si pečlivě přečtěte následující pokyny a uložte si je, abyste se k nim mohli kdykoli vrátit.
- SK** si pozorne prečítajte nasledujúce pokyny a uložte si ich, aby ste sa k nim mohli kedykoľvek vrátiť.
- SL** skrbno preberite navodila v nadaljevanju in jih shranite.
- HR** pažljivo pročitajte sljedeće upute i sačuvajte ih za buduću uporabu.
- RO** citiți cu atenție următoarele instrucțiuni și păstrați-le pentru consultare ulterioară.
- HU** használatbavétele előtt figyelmesen olvassa el az alábbi tudnivalókat, és tartsa azokat később is hozzáférhető helyen
- EL** διαβάστε προσεκτικά τις παρακάτω οδηγίες και φυλάξτε τις για μελλοντική αναφορά.
- TR** kullanmadan önce aşağıdaki talimatları dikkatle okuyun ve gelecekte başvurmak amacıyla saklayın.
- MT** jekk jogħġbok aqra l-istruzzjonijiet li ġejjin bir-reġqa u zommhom għal referenza futura.

**HE** קרא את ההוראות להלן בקפידה ושומר עליהן לעיון במועד מאוחר יותר.  
**AR** يرجى قراءة التعليمات التالية بعناية والاحتفاظ بها للرجوع إليها في المستقبل.

**ZH (CN)** 请仔细阅读以下说明，并保留该说明以供日后参考。

**ZH (TW)** 請詳閱以下說明，並妥善保管以便未來參考使用。

**JA** をご利用になる前に、以下の手順を最後までお読みいただき、今後も参照できるように保管してください。

**KO** 을 사용하기 전에 다음 지침을 잘 읽고 나중에 참고할 수 있도록 보관해 주십시오.

**TH** โปรดอ่านคำแนะนำต่อไปนี้อย่างละเอียดและเก็บไว้เพื่อใช้อ้างอิงในอนาคต

**MS** sila baca arahan berikut dengan teliti dan simpan arahan ini untuk rujukan masa hadapan.

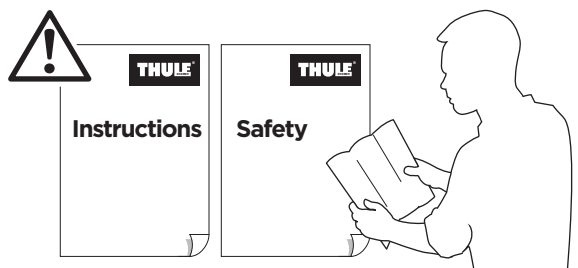

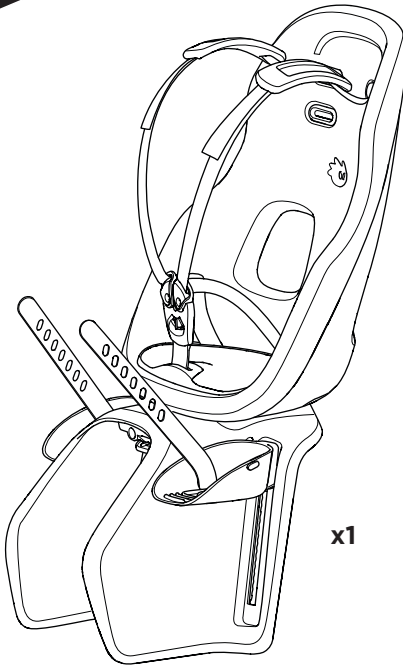

x1

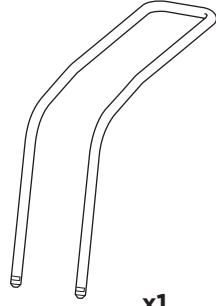

x1



x1



x1



x1



x2

 **x4**  
M6x44  
M6x1.7 inch

 **x4**  
M6x58  
M6x2.3 inch



9-72 M	9-72 M
9-22 kg	20-40 lbs
110 cm	43.3 inch

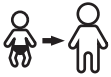

**i**



Your Key-Number



**0-9 M**



**s.1**



Circular



Ø 28-40 mm  
Ø 1,10-1,57 inch

Oval



Max 40 mm  
Max 1,57 inch



Triangular



Square



Carbon Fiber Bike



May cause frame damage

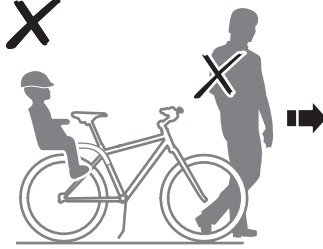
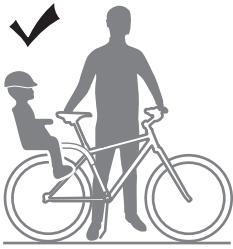

Max. 25 km/h  
15 mph

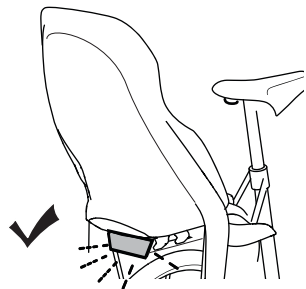
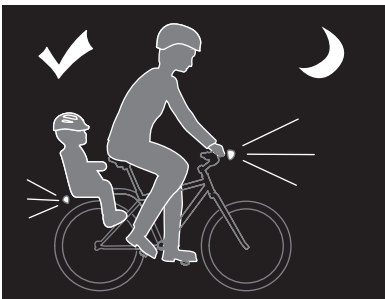
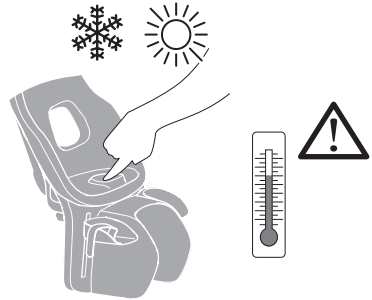
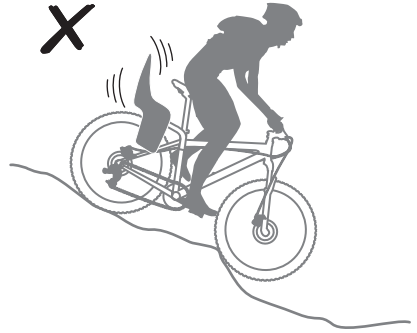
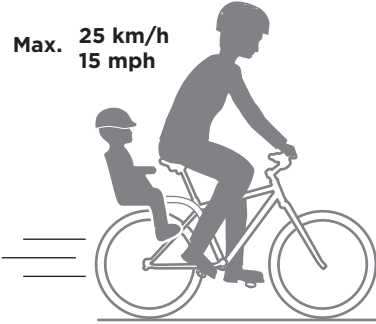

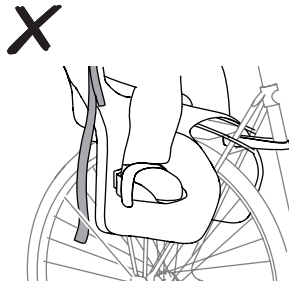
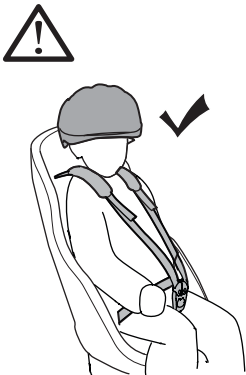
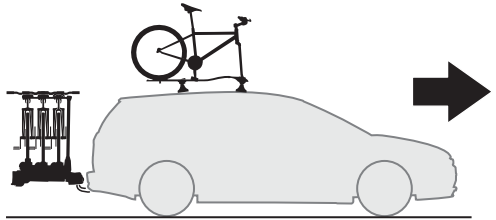
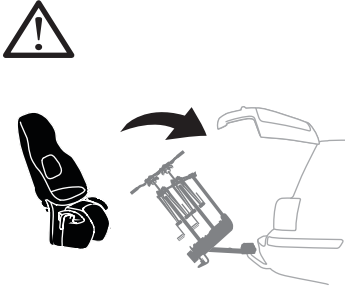
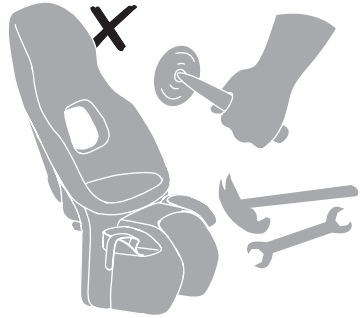
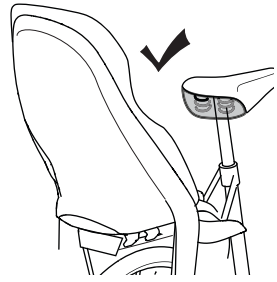
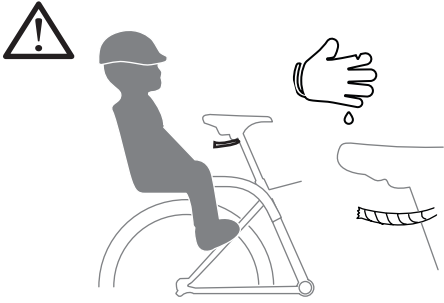

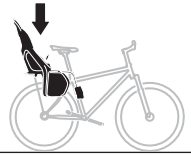

1

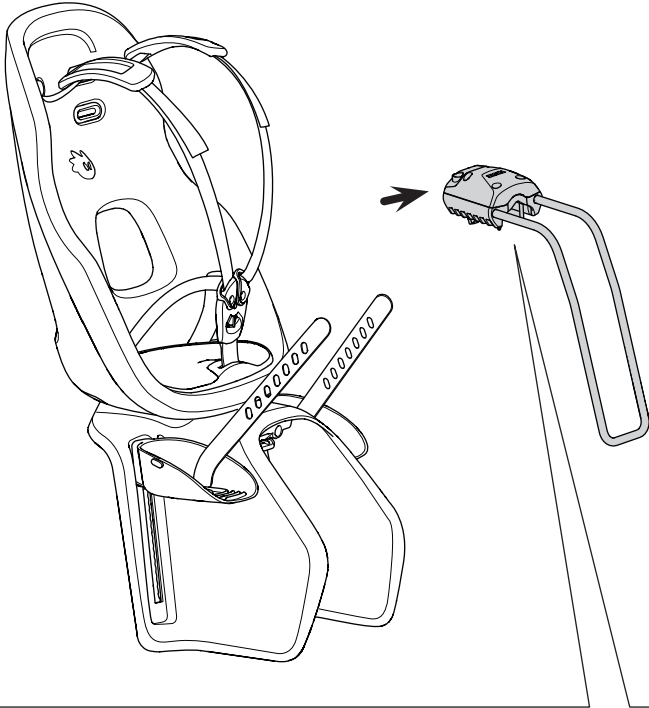

A

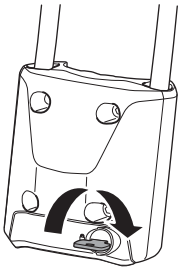

B

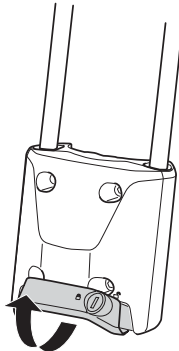

C

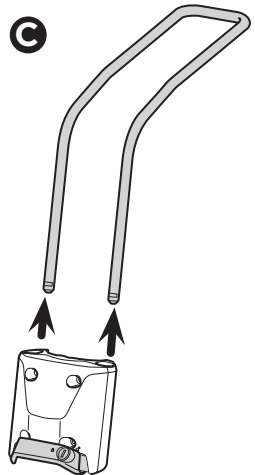



2

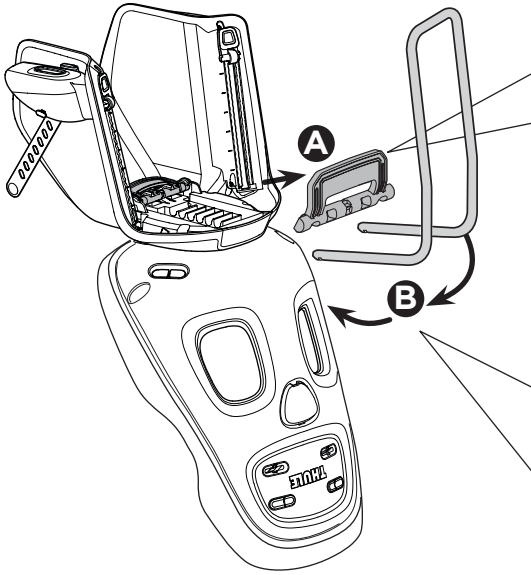

A

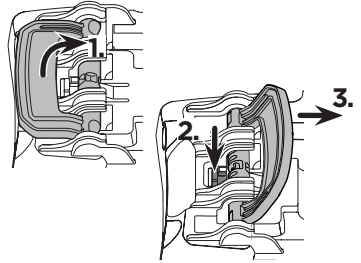

B

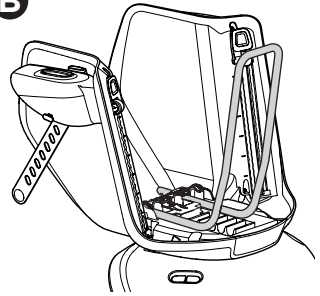

3

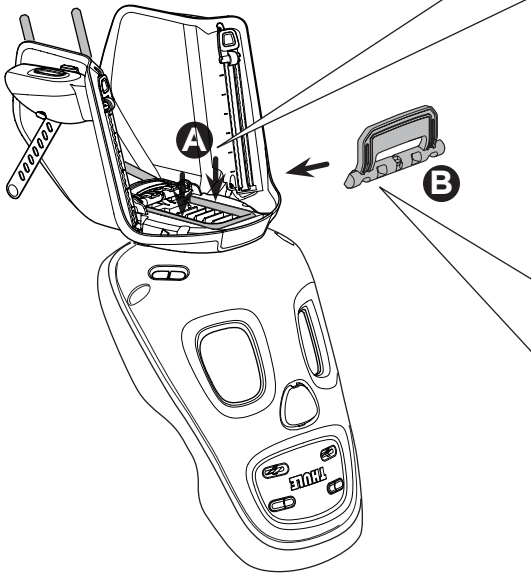

A

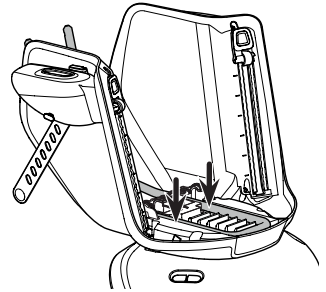

B

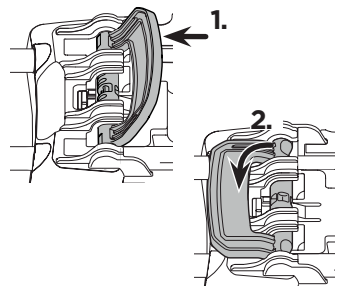

4

Ø 28-40 mm  
Ø 1.10-1.57 inch

40x55 mm  
1.57-2.16 inch

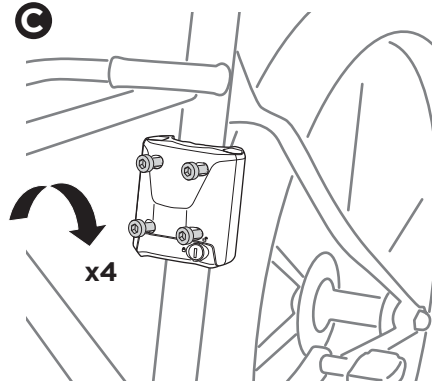
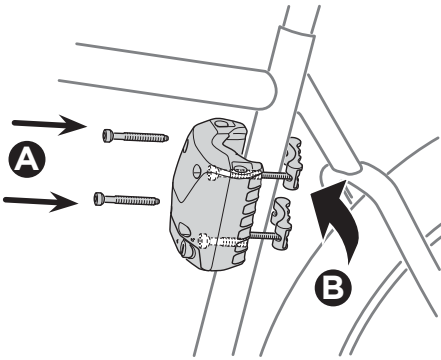
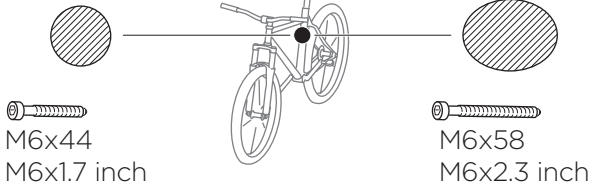

5

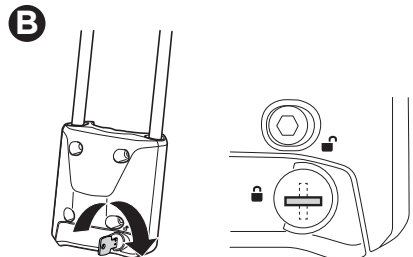
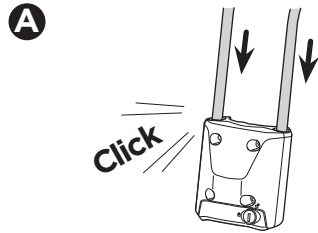
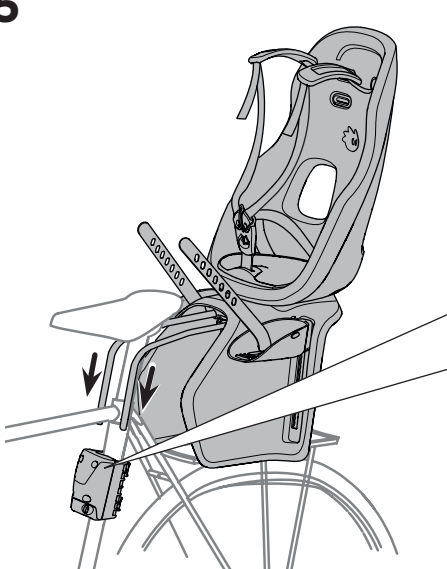

6

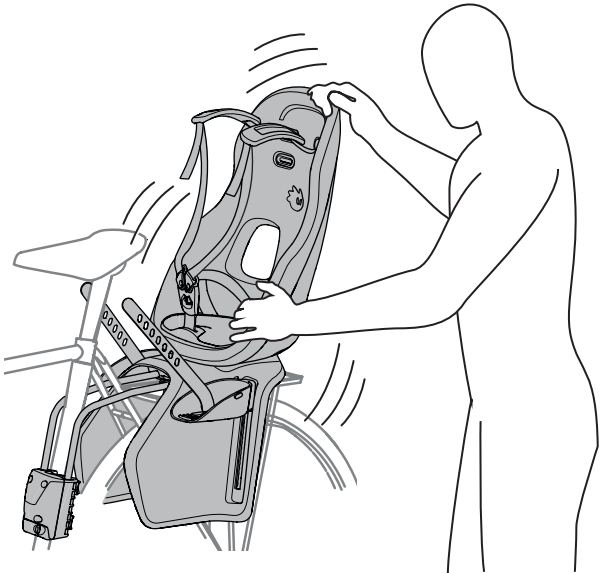
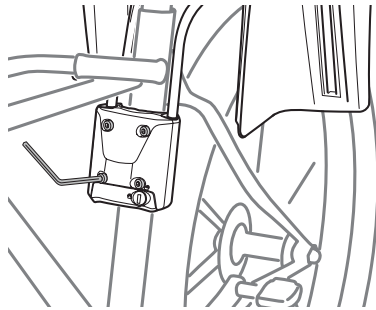
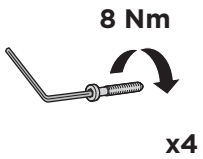
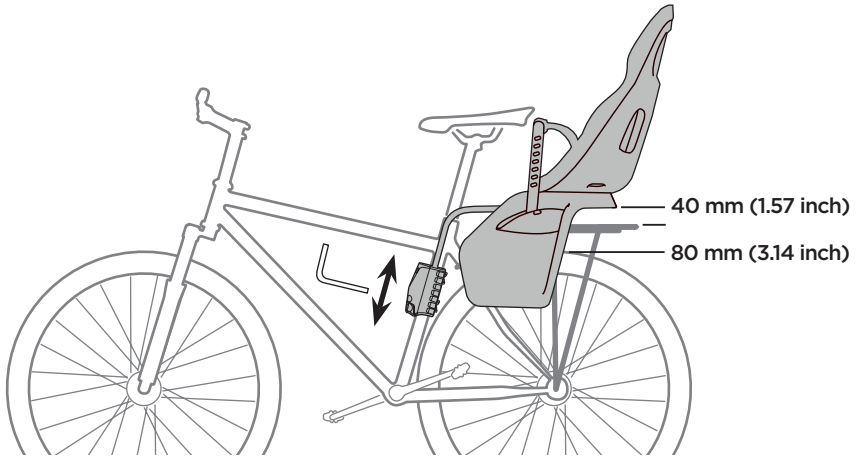

7

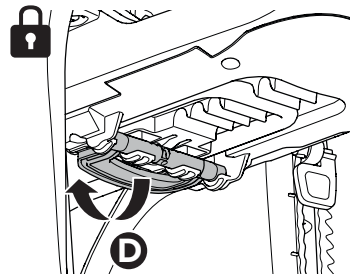
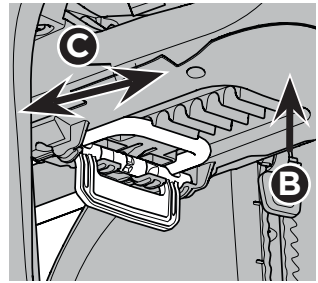
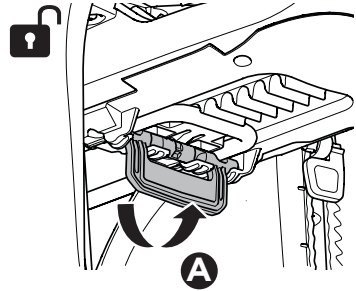
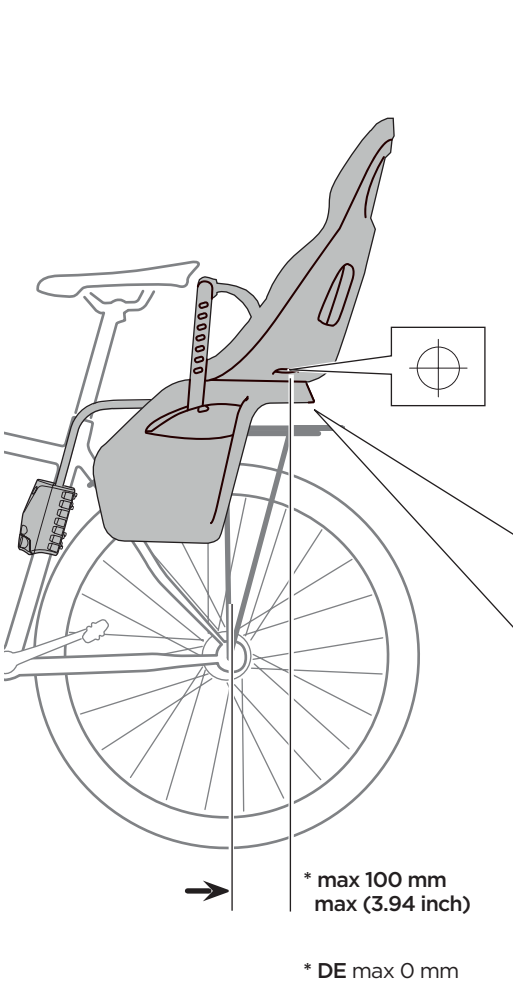
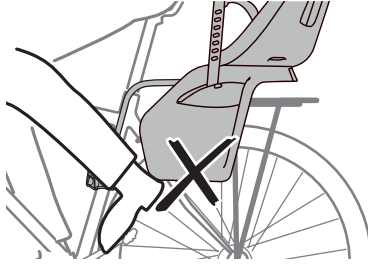



**1**

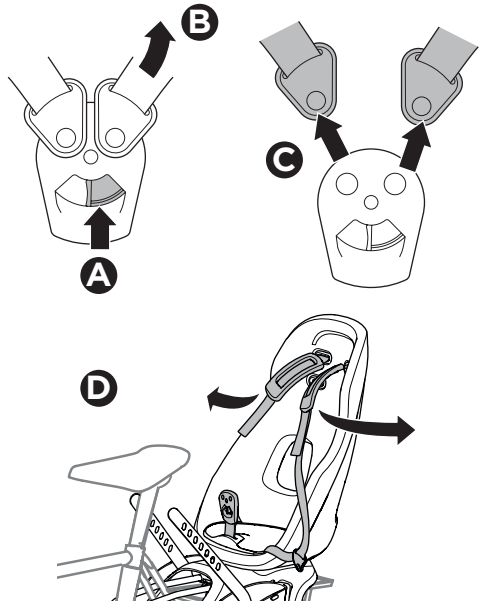
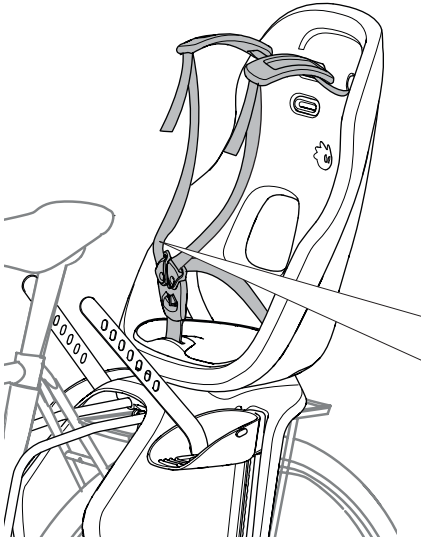

**2**

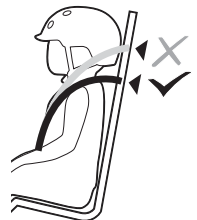
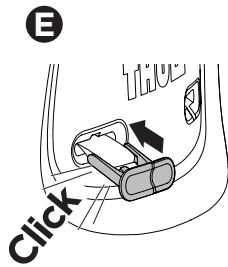
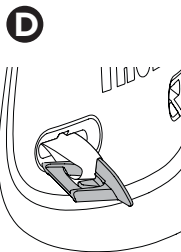
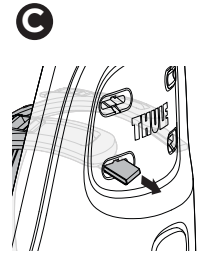
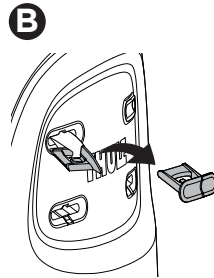
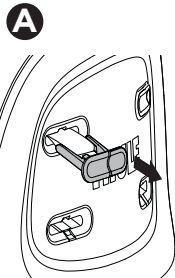
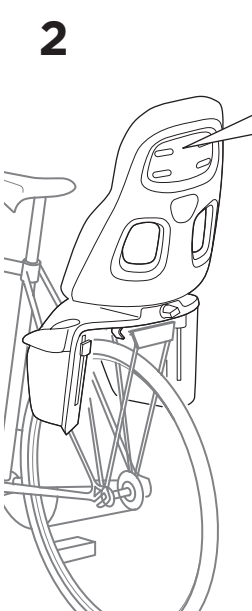

3

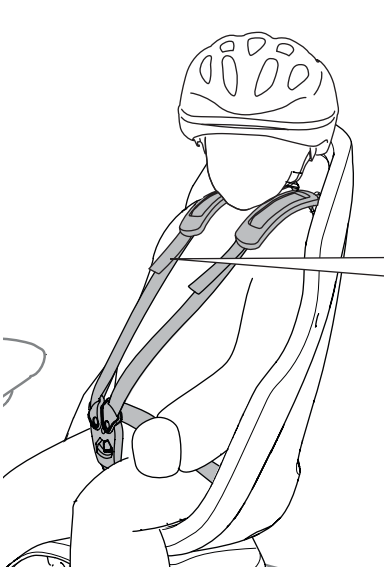

A

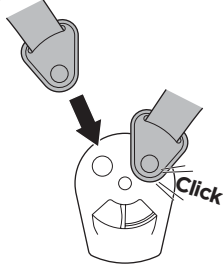

B

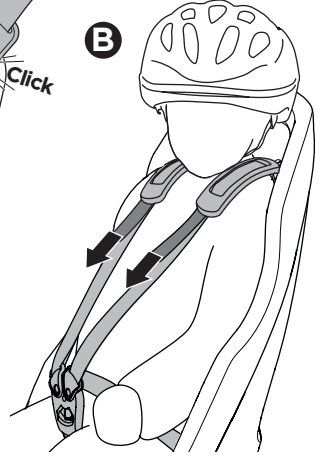

4

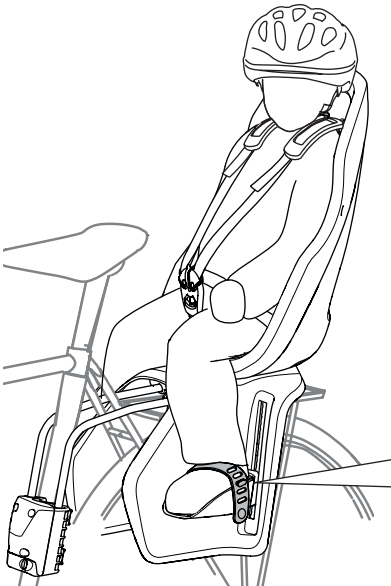

A

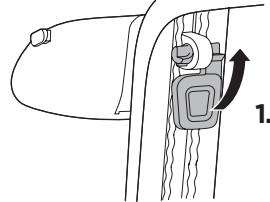

B

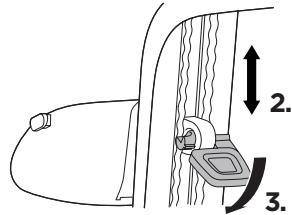

C

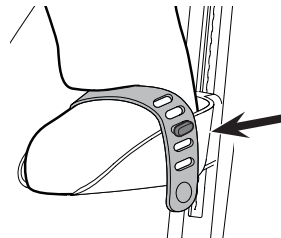

**i**

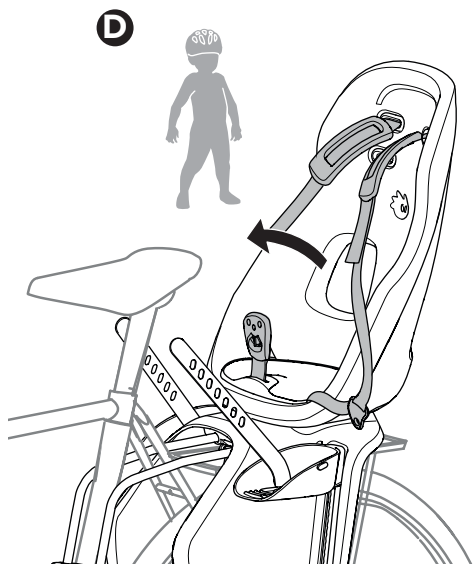
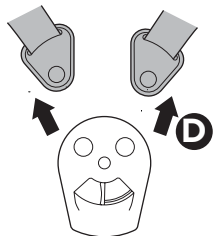
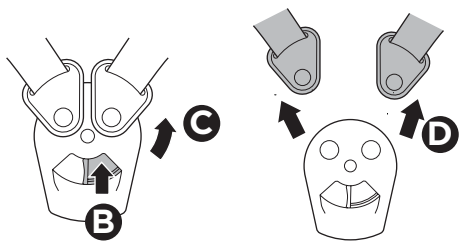
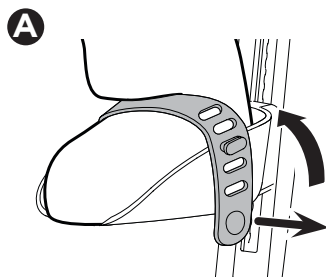
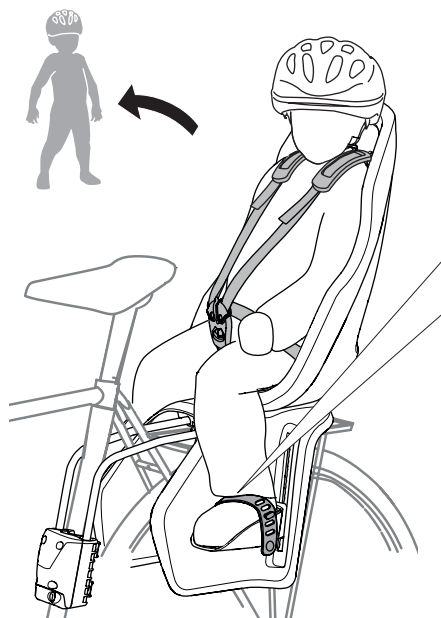

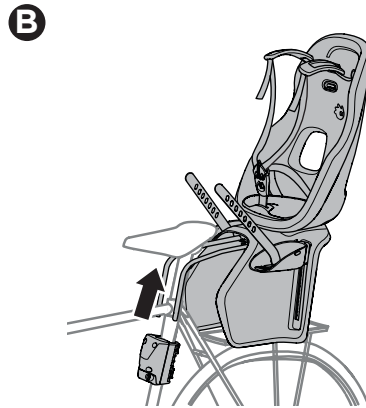
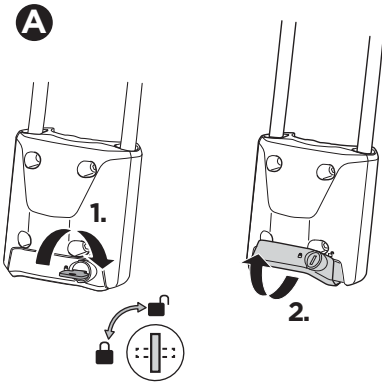
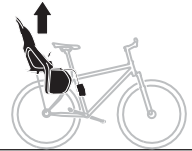

EN Accessories  
 FR Accessoires  
 ES Accesorios  
 DE Zubehör  
 NL Accessoires  
 PT Acessórios  
 IT Accessori  
 SV Tillbehör  
 DK Tilbehør  
 NO Tilbehør  
 FI Lisävarusteet  
 IS Aukabúnaður

ET Tarvikud  
 LV Piederumi  
 LT Priedai  
 RU Аксессуары  
 UK Аксесуары  
 PL Akcesoria  
 CS Příslušenství  
 HU Kiegészítők  
 RO Accesorii  
 SK Príslušenstvo  
 SL Dodatna oprema  
 BG Аксесоари

HR Dodatna oprema  
 EL Αξεσουάρ  
 TR Aksesuarlar  
 MT Accessorji

אביזרים HE  
 الملحقات AR

ZH (CN) 附件  
 ZH (TW) 配件  
 JA アクセサリー  
 KO 액세서리  
 TH อุปกรณ์เสริม  
 MS Aksesorii

### Thule Yepp Raincover 12020972



### Thule Delight 20201516

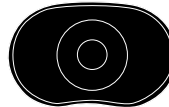

### Thule Quick Release Bracket 100203



### Thule Yepp Harness Clip 12020920

