

➤ Instructions

Thule Yepp 2 Maxi Rack Mount 120212XX

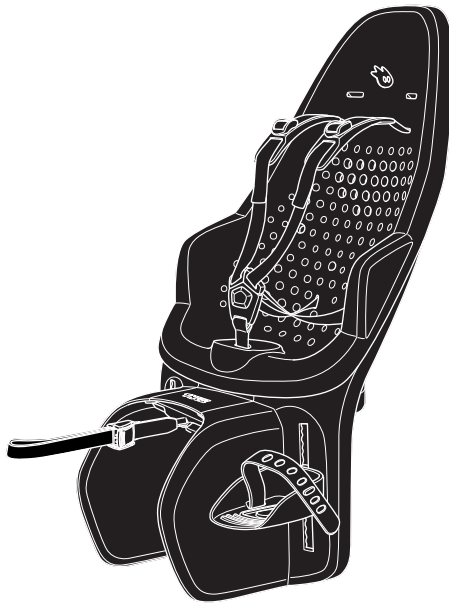

EN	Rear mounted child bike seat	CS	Zadní dětská cyklosedačka
FR	Siège vélo enfant arrière	HU	Kerékpáros hátsó gyerekülés
ES	Asiento para niños en la parte trasera de la bicicleta	RO	Scaun spate de copii pentru bicicletă
DE	Fahrradkindersitz	SK	Zadná dětská cyklosedačka
NL	Fietszitje voor achterop	SL	Zadnji otroški kolesarski sedež
PT	Assento infantil traseiro para bicicleta	BG	Задна детска седалка за велосипед
IT	Seggiolino da bicicletta posteriore	HR	Dječja sjedalica za bicikl koja se postavlja straga
SV	Cykelbarnstol för bakre cykelmontering	EL	Πίσω παιδικό κάθισμα ποδηλάτου
DK	Bagmonteret cykelstol	TR	Arkaya Bağlanan Çocuk Bisiklet Koltuğu
NO	Bakmontert barnesykkelse	MT	Sedil tar-Rota għat-Tfal li Jitpoġġa Wara
FI	Lastenistuin polkupyörän taakse		מושב אופניים אחורי לילד HE
IS	Barnasæti aftan á reiðhjól		مقعد الدراجة الخلفي للطفل AR
ET	Jalgratta tagumine lasteiste	ZH (CN)	后置式儿童自行车座椅
LV	Velosipēda aizmugurējais bērna sēdekļis	ZH (TW)	後座式自行車兒童座椅
LT	Galinė vaikiška dviračio kėdutė	JA	サイクル後部用チャイルドシート
RU	Заднее детское велосипедное сиденье	KO	후면 어린이 자전거 시트
UK	Заднє дитяче велосипедне крісло	TH	เก้าอี้เด็กสำหรับซ้อนท้ายจักรยาน
PL	Fotelik rowerowy do przewożenia dziecka montowany z tyłu	MS	Tempat Duduk Basikal Kanak-kanak Belakang

EN 14344:2022

ASTM F1625-00



- EN** Please read the following instructions carefully and keep them for future reference.
- DE** Bitte die folgenden Anleitung aufmerksam durch und bewahren Sie sie zum späteren Nachschlagen auf.
- FR** Veuillez lire attentivement les instructions suivantes et les conserver pour référence future.
- NL** Dient u zorgvuldig de volgende instructies te lezen en deze als toekomstig naslagwerk te bewaren.
- IT** Leggi le seguenti istruzioni attentamente e conservale per consultazioni future.
- ES** Lea las instrucciones siguientes atentamente y guárdelas para consultas posteriores.
- PT** Leia cuidadosamente as instruções a seguir e guarde-as para referência futura.
- SV** Vi ber dig läsa följande instruktioner noggrant och därefter behålla dem för framtida bruk.
- DK** Skål du læse følgende anvisninger grundigt igennem og gemme dem til fremtidig reference.
- NO** Bør du lese disse instruksjonene nøye. Ta vare på dem i tilfelle du får bruk for dem senere.
- FI** Lue seuraavat ohjeet huolellisesti. Pidä ohjeet tallessa.
- IS** Lestu þessar leiðbeiningar vandlega áður en þú og geymdu þær til síðari nota.
- ET** kasutuselevõttu lugege järgmised juhised hoolikalt läbi ja hoidke need alles.
- LV** lūdzu, izlasiet uzmanīgi tālāk sniegtos norādījumus un saglabājiet tos turpmākai izmantošanai.
- LT** atidžiai perskaitykite toliau pateiktas instrukcijas ir jų neišmeskite, kad galėtumėte peržiūrėti ateityje.
- PL** należy dokładnie przeczytać następujące instrukcje i zachować je do wykorzystania w przyszłości.
- RU** внимательно изучите представленные ниже инструкции и сохраните их для дальнейшего использования.
- UK** ознайомтеся з нижченаведеними інструкціями й зберігайте їх для довідки в майбутньому.
- BG** прочетете внимателно следните инструкции и ги запазете за бъдещи справки.
- CS** si pečlivě přečtěte následující pokyny a uložte si je, abyste se k nim mohli kdykoli vrátit.
- SK** si pozorne prečítajte nasledujúce pokyny a uložte si ich, aby ste sa k nim mohli kedykoľvek vrátiť.
- SL** skrbno preberite navodila v nadaljevanju in jih shranite.
- HR** pažljivo pročitajte sljedeće upute i sačuvajte ih za buduću uporabu.
- RO** citiți cu atenție următoarele instrucțiuni și păstrați-le pentru consultare ulterioară.
- HU** használatbavétele előtt figyelmesen olvassa el az alábbi tudnivalókat, és tartsa azokat később is hozzáférhető helyen
- EL** διαβάστε προσεκτικά τις παρακάτω οδηγίες και φυλάξτε τις για μελλοντική αναφορά.
- TR** kullanmadan önce aşağıdaki talimatları dikkatle okuyun ve gelecekte başvurmak amacıyla saklayın.
- MT** jekk jogħġbok aqra l-istruzzjonijiet li ġejjin bir-reġqa u zommhom għal referenza futura.

HE קרא את ההוראות להלן בקפידה ושומר עליהן לעיון במועד מאוחר יותר.
AR يرجى قراءة التعليمات التالية بعناية والاحتفاظ بها للرجوع إليها في المستقبل.

ZH (CN) 请仔细阅读以下说明，并保留该说明以供日后参考。

ZH (TW) 請詳閱以下說明，並妥善保管以便未來參考使用。

JA をご利用になる前に、以下の手順を最後までお読みいただき、今後も参照できるように保管してください。

KO 을 사용하기 전에 다음 지침을 잘 읽고 나중에 참고할 수 있도록 보관해 주십시오.

TH โปรดอ่านคำแนะนำต่อไปนี้อย่างละเอียดและเก็บไว้เพื่อใช้อ้างอิงในอนาคต

MS sila baca arahan berikut dengan teliti dan simpan arahan ini untuk rujukan masa hadapan.

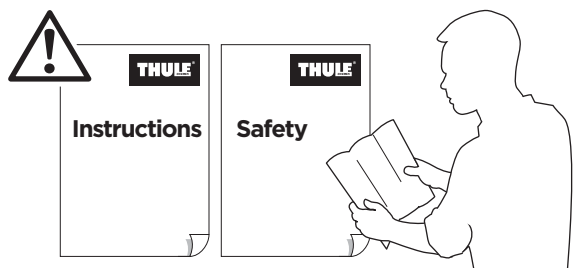

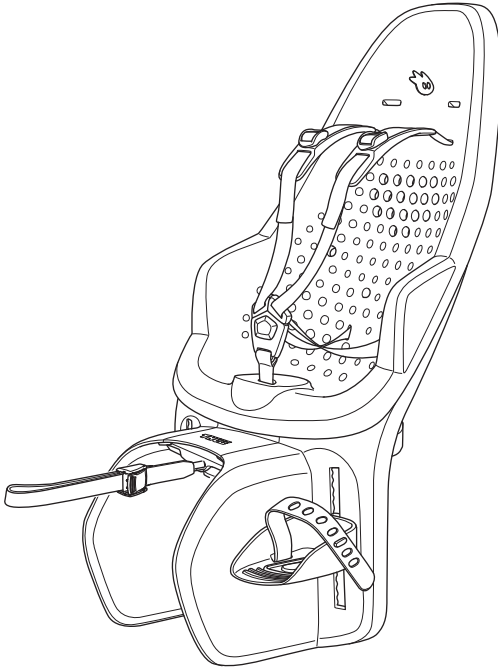

	
9-72 M	9-72 M
9-22 kg	20-40 lbs
110 cm	43.3 inch



Your Key-Number



0-9 M



s.1



Ø 11 - 28.6 mm
Ø 0.43 - 1.13 inch

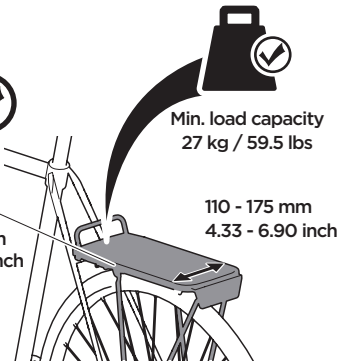

Min. load capacity
27 kg / 59.5 lbs

110 - 175 mm
4.33 - 6.90 inch



Ø 11 - 28.6 mm
Ø 0.43 - 1.13 inch

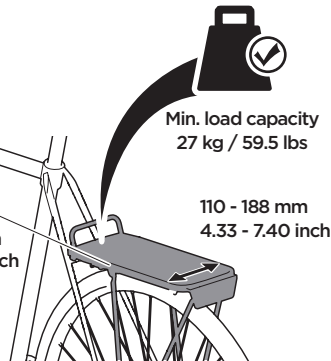

Min. load capacity
27 kg / 59.5 lbs

110 - 188 mm
4.33 - 7.40 inch

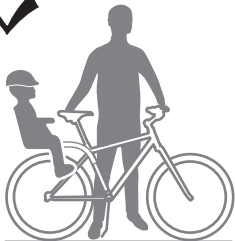

Max. 25 km/h
15 mph



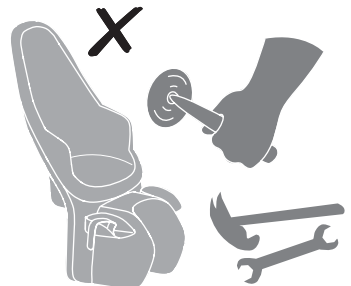
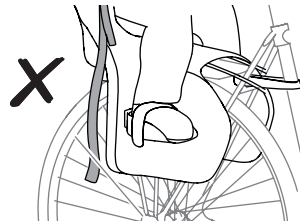
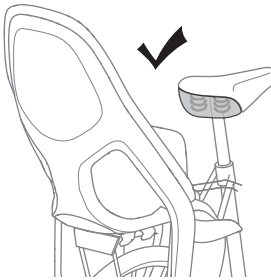
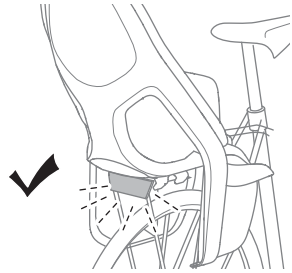
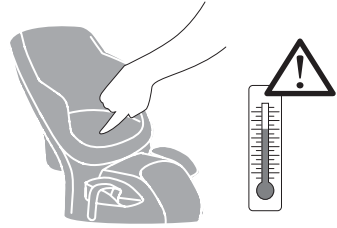

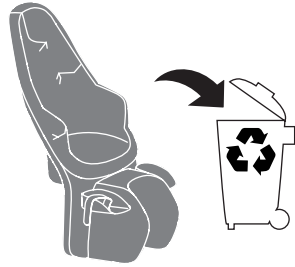
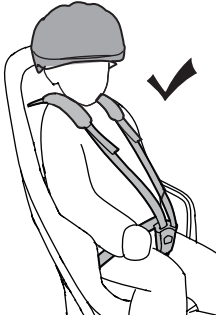
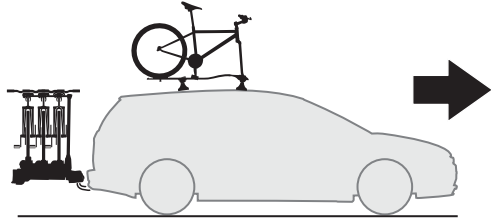
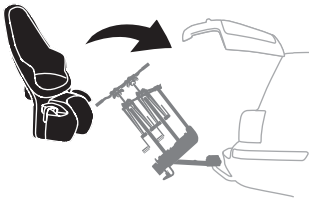

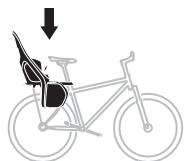

1

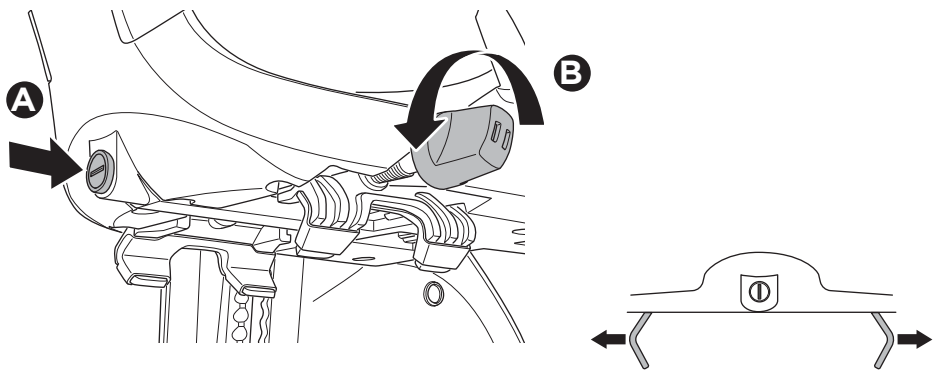
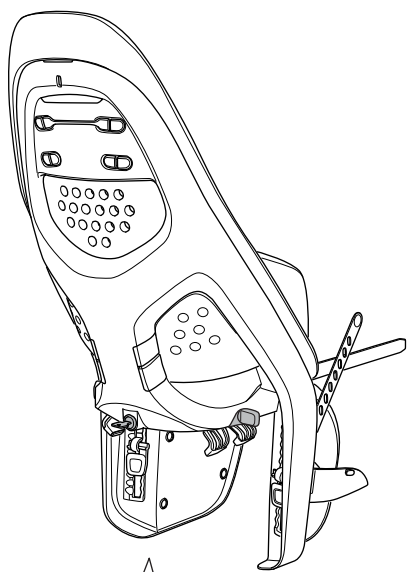

2

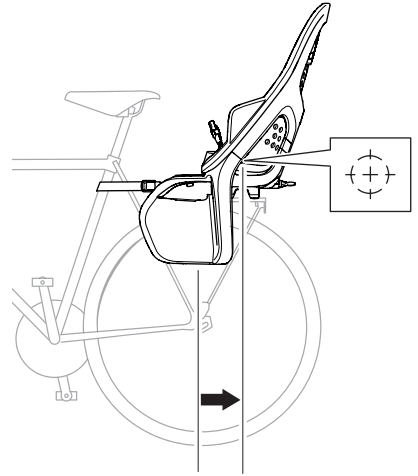
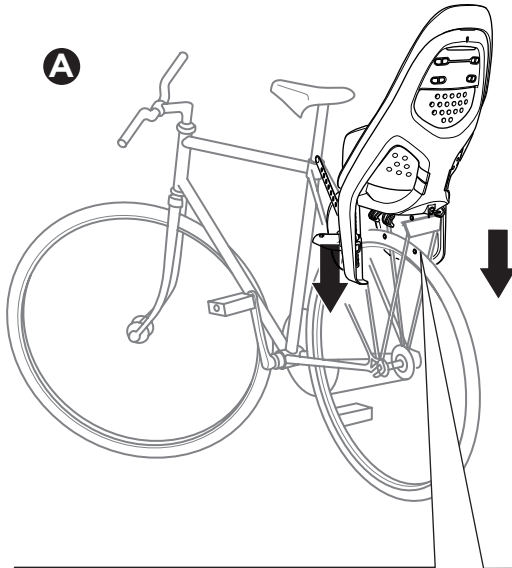

* max 100 mm
max (3.94 inch)

* DE max 0 mm

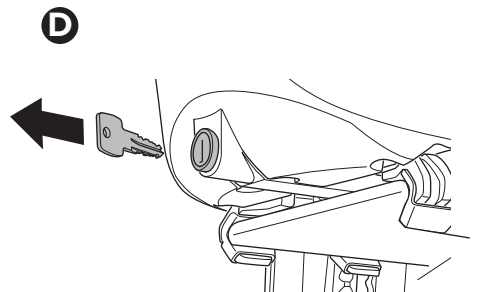
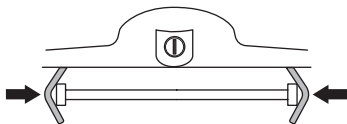
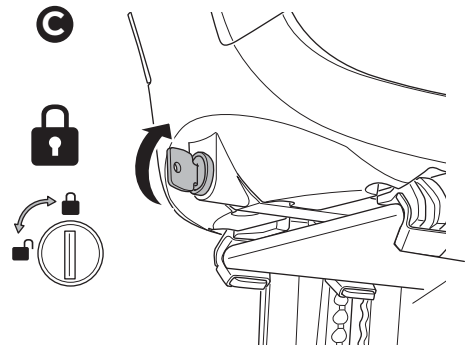
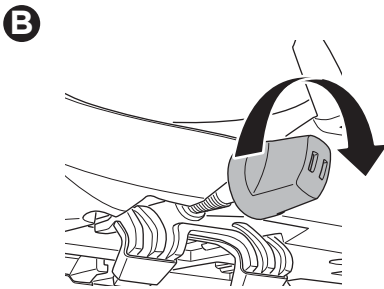

3

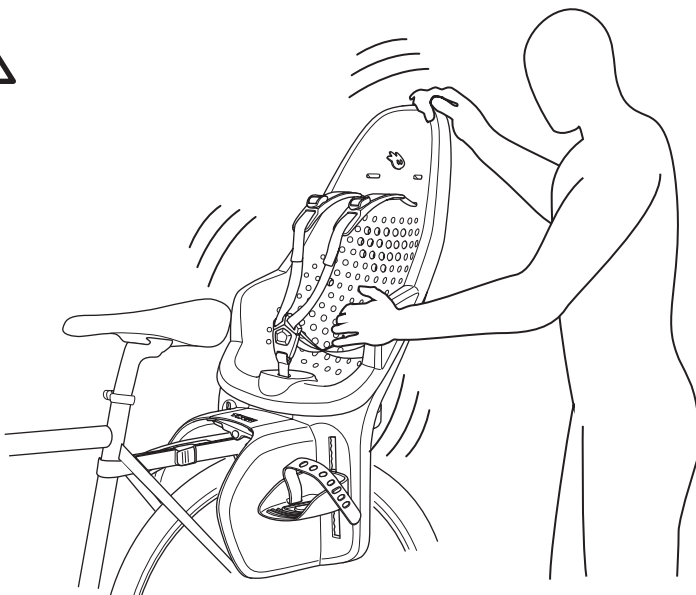
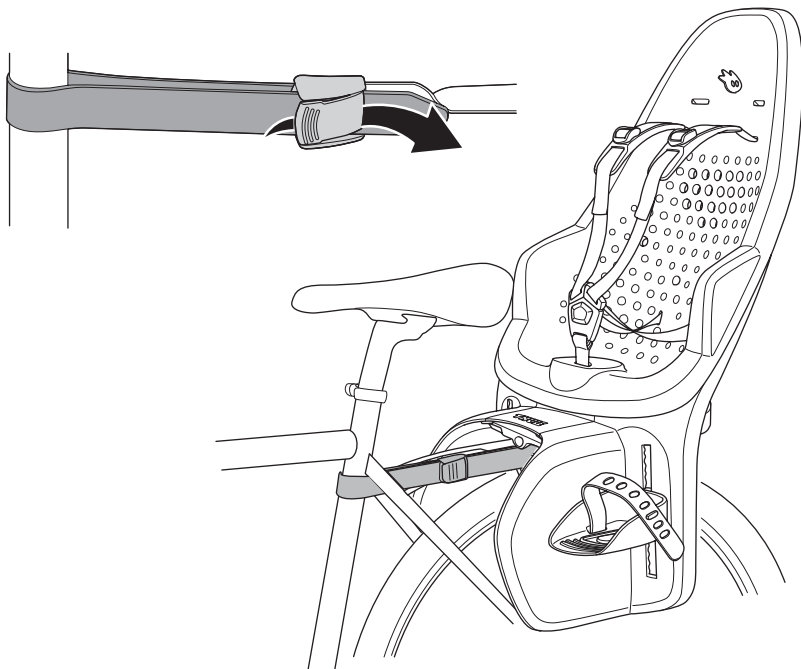



1

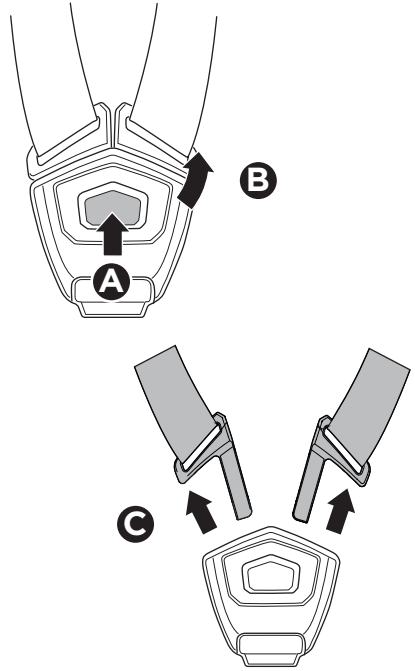
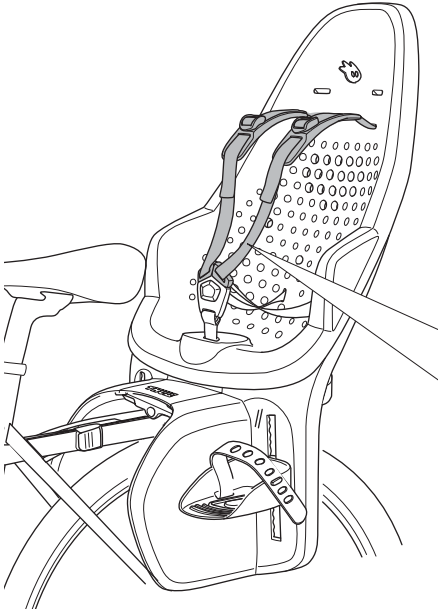

2

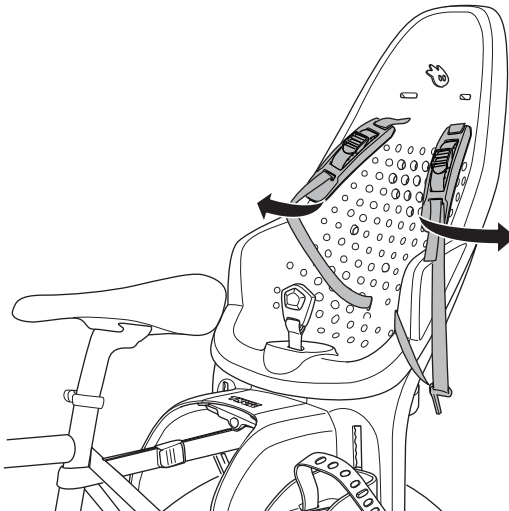

3

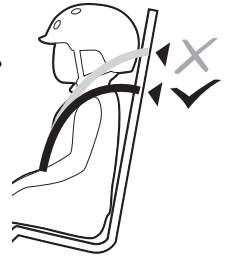
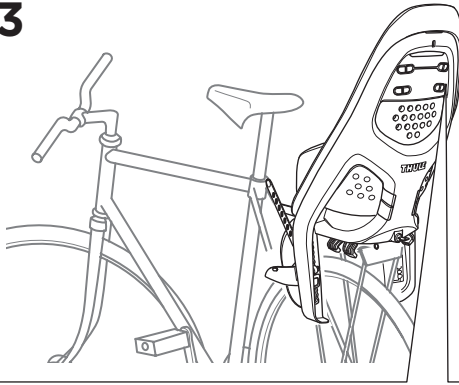

A

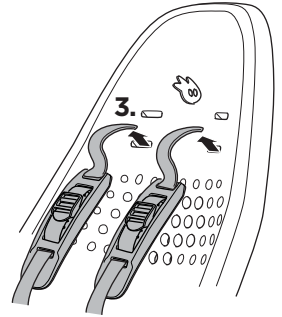
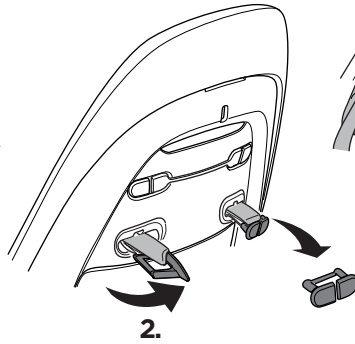
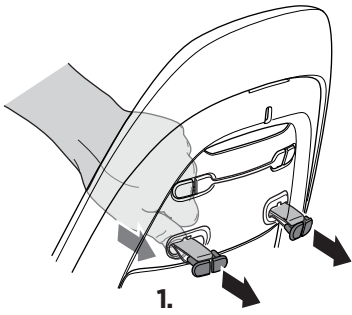

B

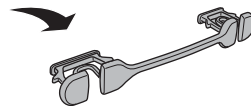
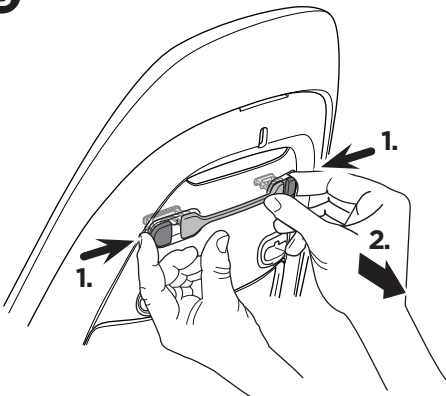

C

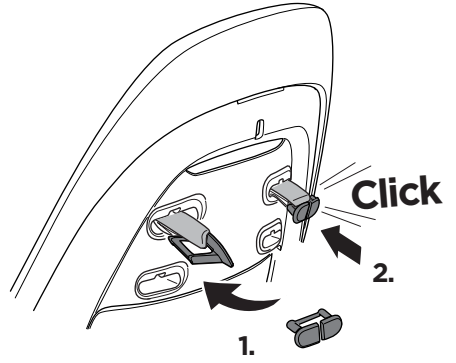
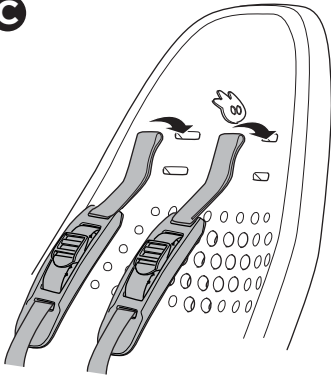

D

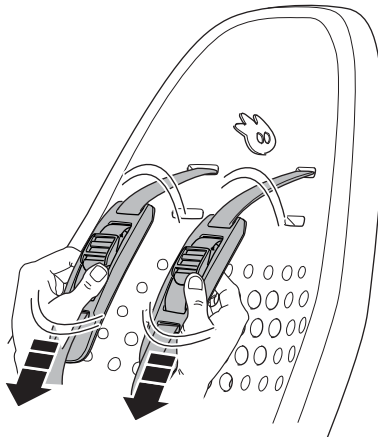
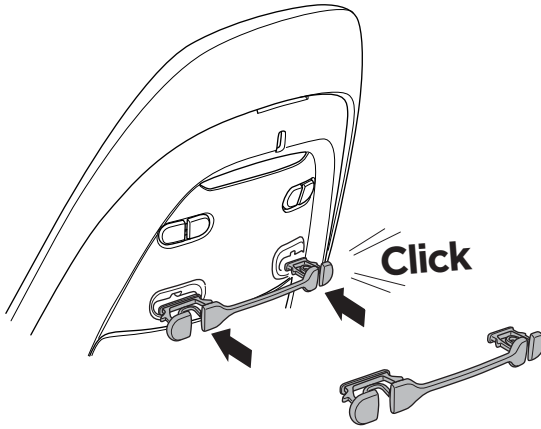

4

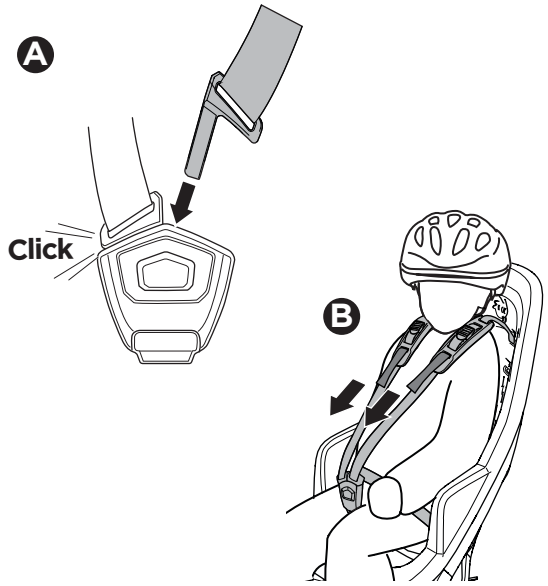
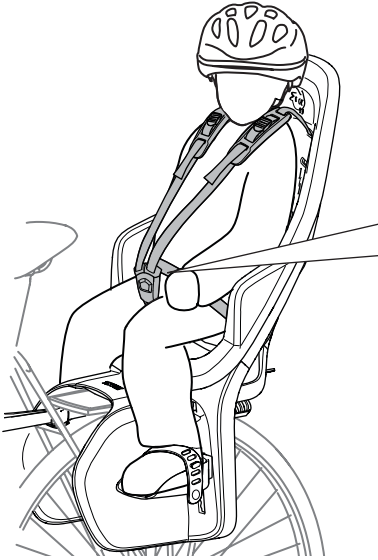

5

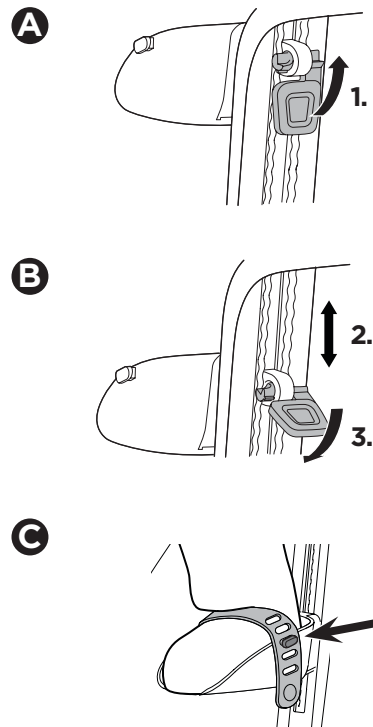
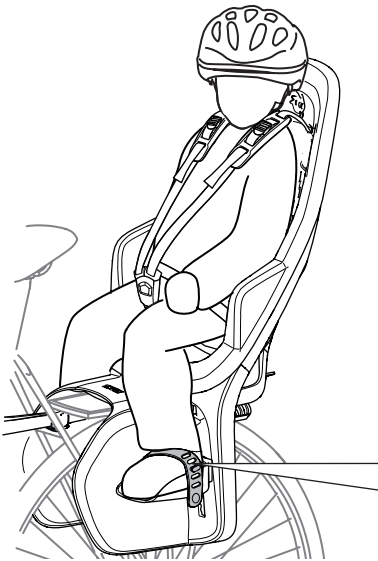

i

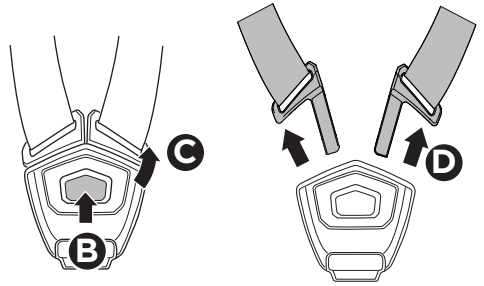
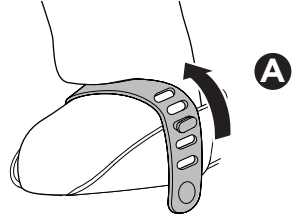
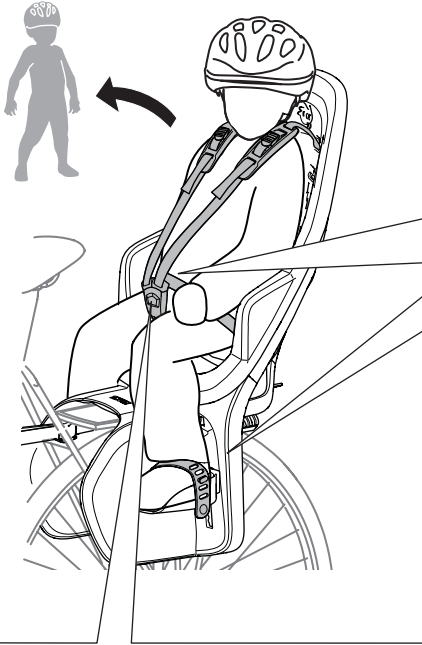

D

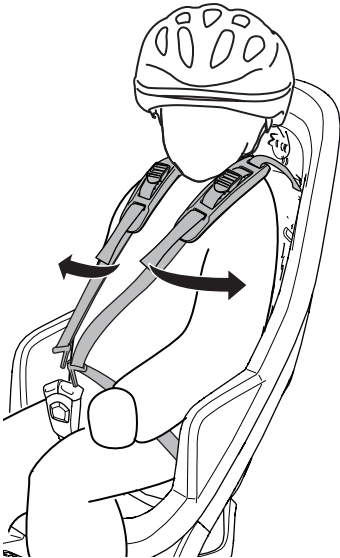

E

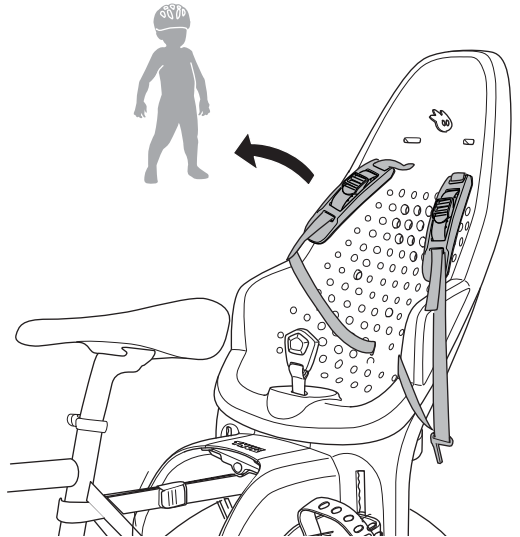

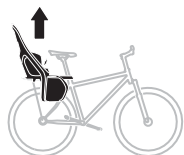

i

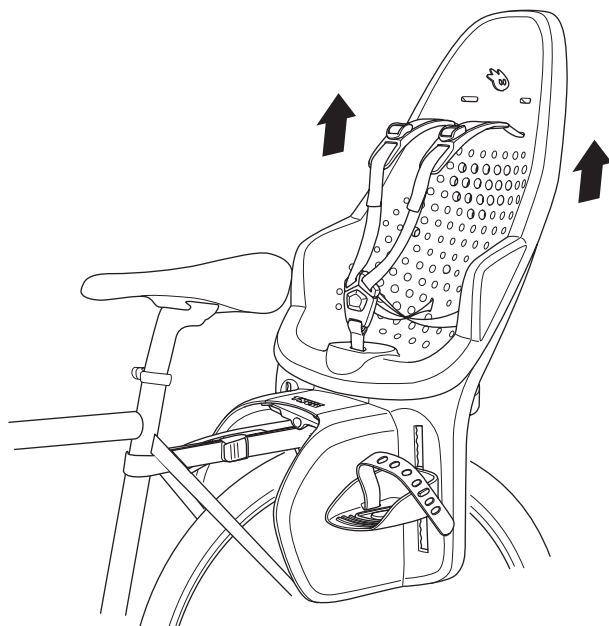

A

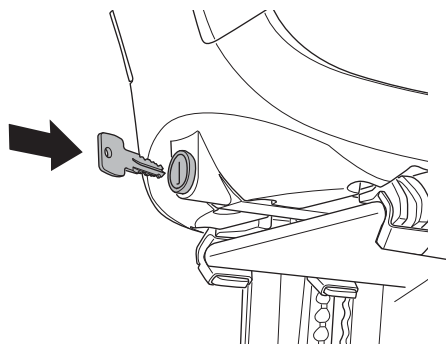

B

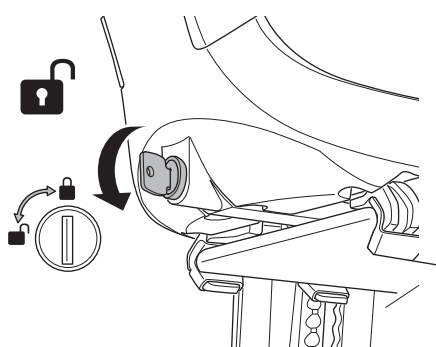

C

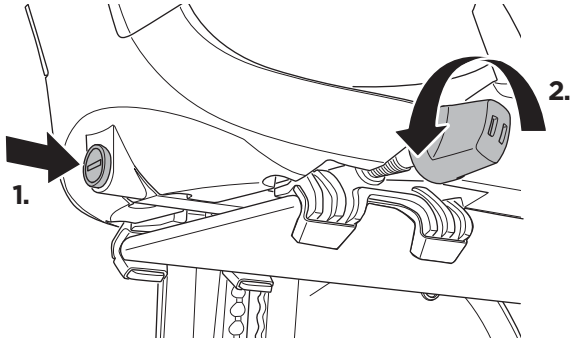

D

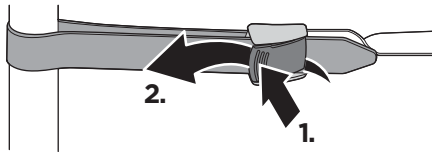

E

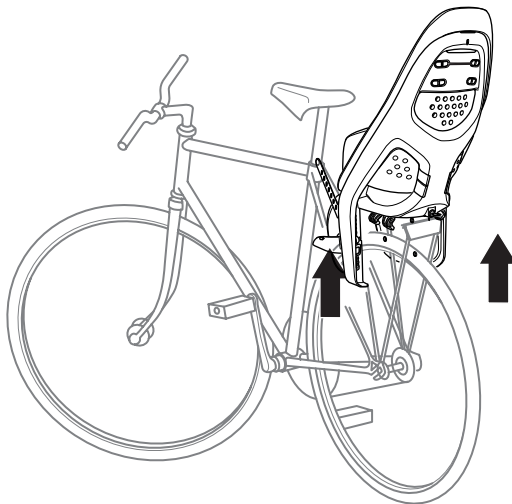

EN Accessories
FR Accessoires
ES Accesorios
DE Zubehör
NL Accessoires
PT Acessórios
IT Accessori
SV Tillbehör
DK Tilbehør
NO Tilbehør
FI Lisävarusteet
IS Aukabúnaður

ET Tarvikud
LV Piederumi
LT Priedai
RU Аксессуары
UK Аксесуари
PL Akcesoria
CS Příslušenství
HU Kiegészítők
RO Accesorii
SK Príslušenstvo
SL Dodatna oprema
BG Аксесоари

HR Dodatna oprema
EL Αξεσουάρ
TR Aksesuarlar
MT Aċċessorji

אביזרים **HE**
الملحقات **AR**

ZH (CN) 附件
ZH (TW) 配件
JA アクセサリー
KO 액세서리
TH อุปกรณ์เสริม
MS Aksesori

Thule Yepp Raincover
12020972

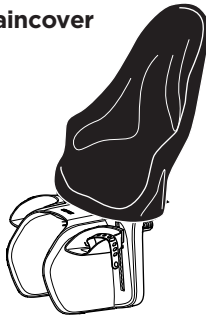

Thule Delight
20201516

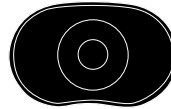

Thule Yepp Harness Clip
12020920

