

1

Kit 5131

MITSUBISHI L200, 4-dr Double Cab, 05-15





MITSUBISHI Triton, 4-dr Double Cab, 05-15

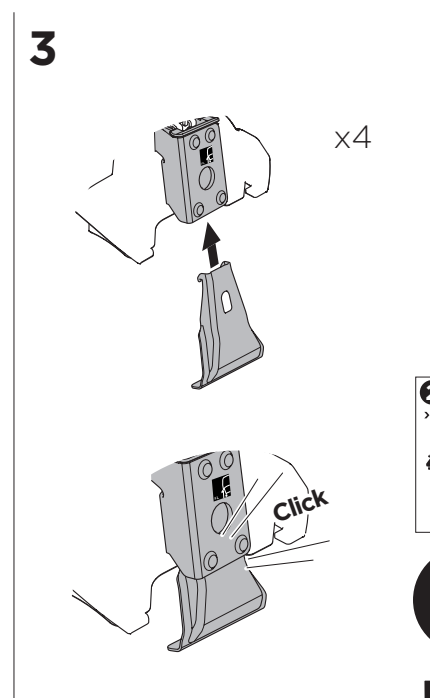
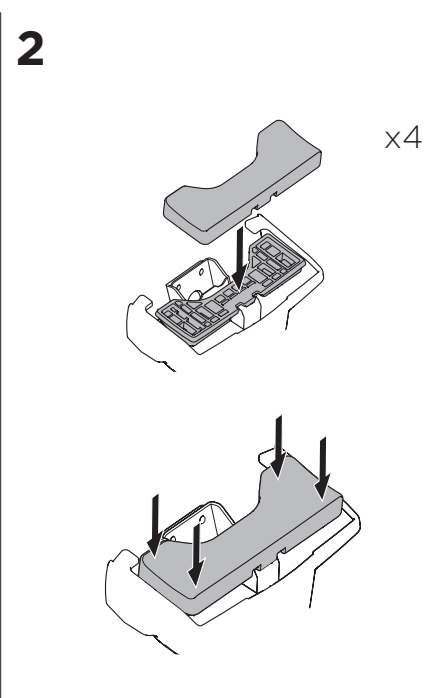
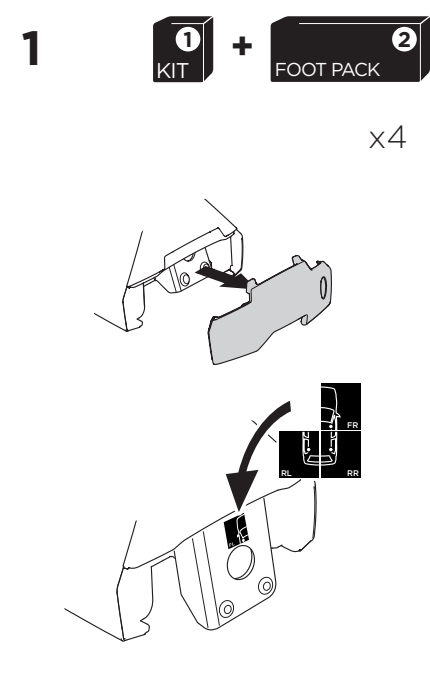
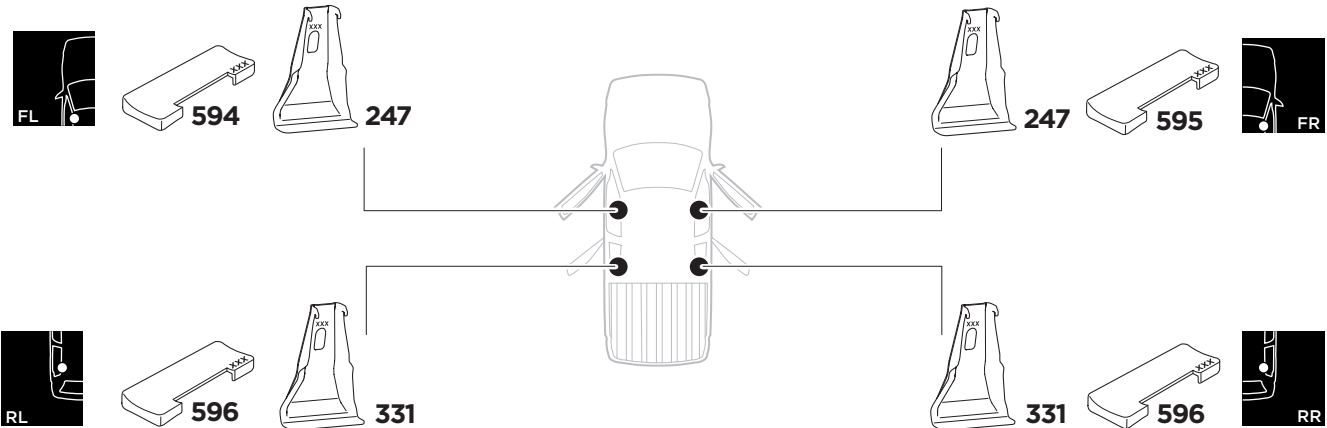
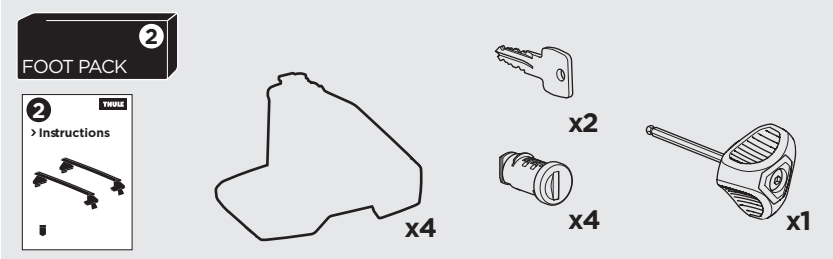
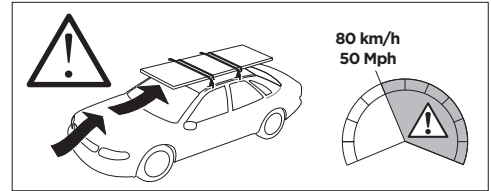
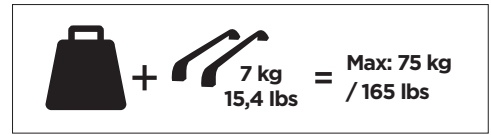
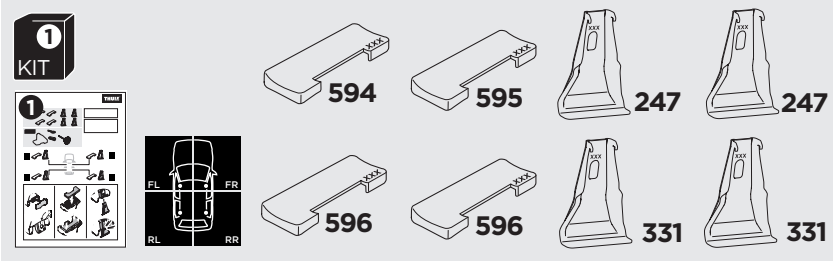

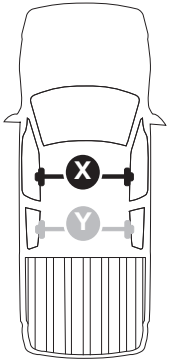

ISO 11154-E









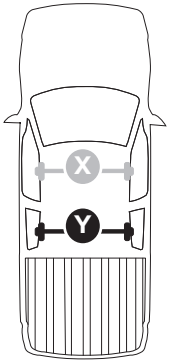

 THULE WingBar Evo	 THULE WingBar Edge	 THULE WingBar	 THULE SquareBar	Evo X (scale)	Edge X (scale)
MITSUBISHI L200, 4-dr Double Cab, 05-15				40,5	P
MITSUBISHI Triton, 4-dr Double Cab, 05-15				40,5	P

 THULE ProBar	 THULE SlideBar	X (mm/inch)	
MITSUBISHI L200, 4-dr Double Cab, 05-15		1056 mm / 41 5/8"	
MITSUBISHI Triton, 4-dr Double Cab, 05-15		1056 mm / 41 5/8"	



 THULE WingBar Evo	 THULE WingBar Edge	 THULE WingBar	 THULE SquareBar	Evo Y (scale)	Edge Y (scale)
MITSUBISHI L200, 4-dr Double Cab, 05-15				33,5	L
MITSUBISHI Triton, 4-dr Double Cab, 05-15				33,5	L

 THULE ProBar	 THULE SlideBar	Y (mm/inch)	
MITSUBISHI L200, 4-dr Double Cab, 05-15		986 mm / 38 7/8"	
MITSUBISHI Triton, 4-dr Double Cab, 05-15		986 mm / 38 7/8"	

	W (mm/inch)	Z (mm/inch)
MITSUBISHI L200, 4-dr Double Cab, 05-15	800 mm / 31 1/2"	350 mm / 13 3/4"
MITSUBISHI Triton, 4-dr Double Cab, 05-15	800 mm / 31 1/2"	350 mm / 13 3/4"

